

Article number: 20276B25MZ2SW

Description: E+G Swivel clamp connector
GN276-B25-MZ-2-SW

Measures

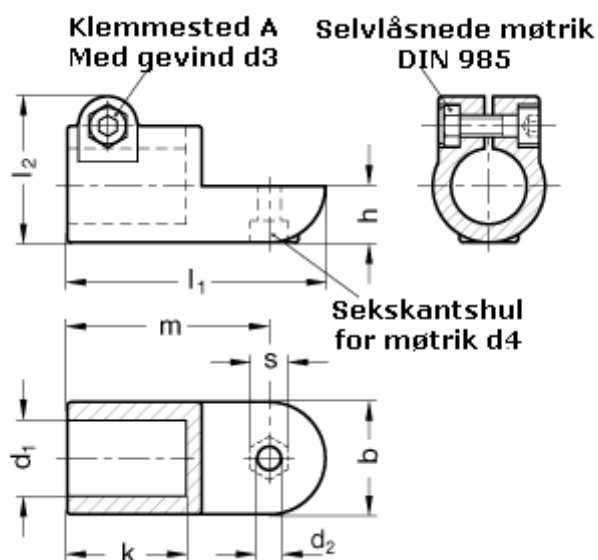

$b = 40$	$m = 72$
$d_1 = B25$	$s = 13$
$d_2 = 8.2$	
$d_3 = M 8$	
$d_4 = M 8$	
$k = 42.5$	
$l_1 = 92$	
$l_2 = 52.0$	